

The line drawings for the aluminium cabinet (K520) 700mm(height)x800mm(width)

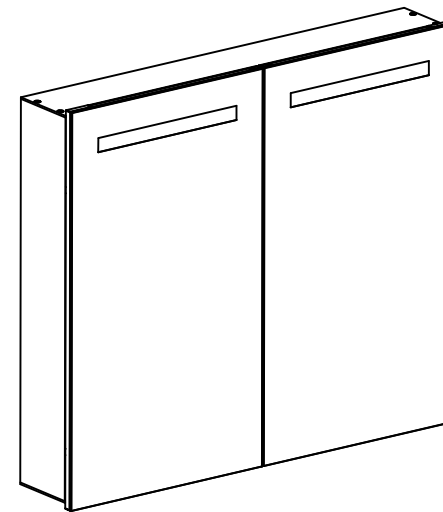

INSTALLATION INSTRUCTIONS

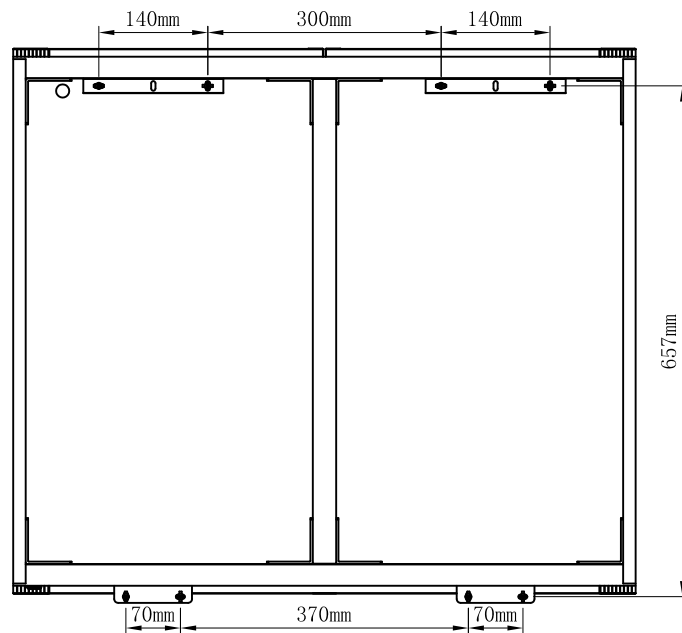

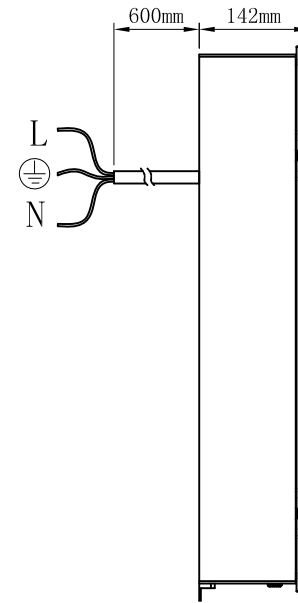
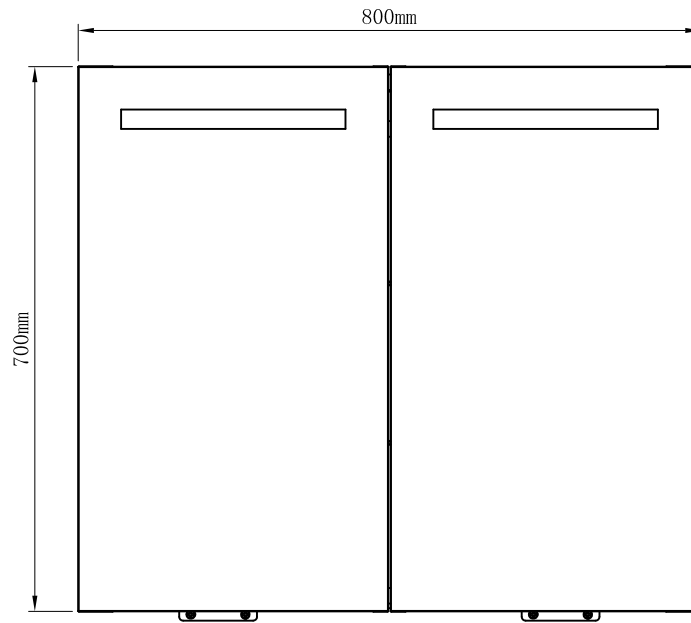
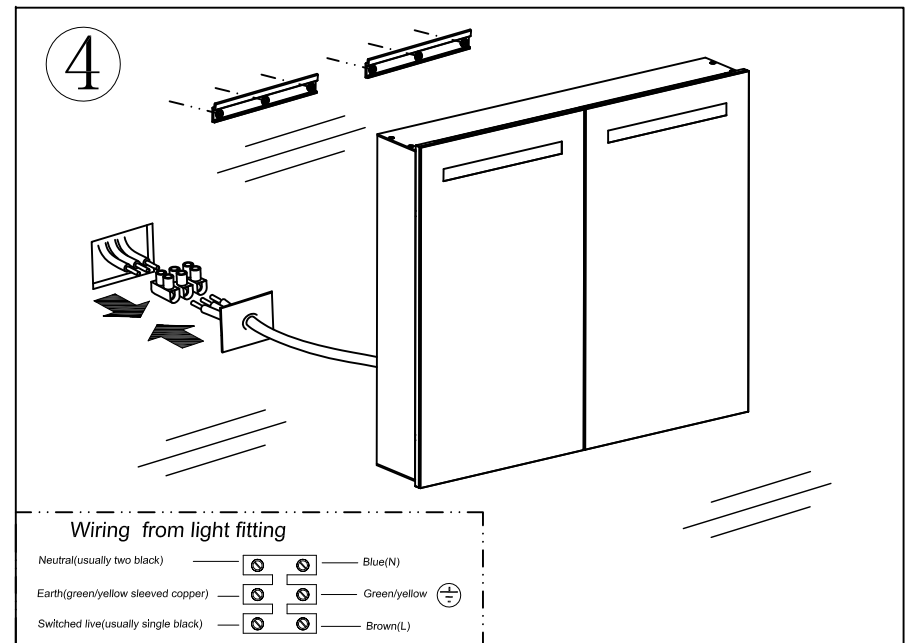
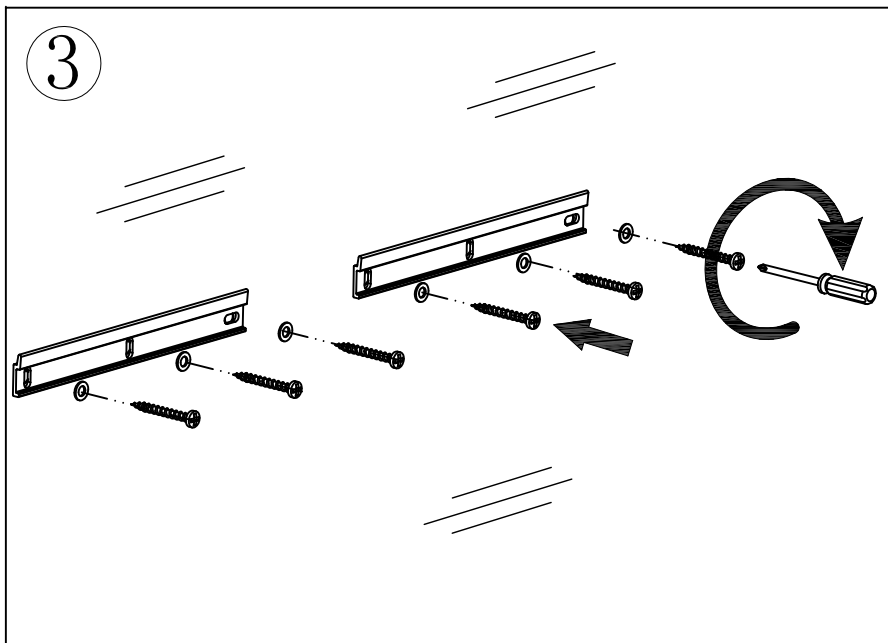
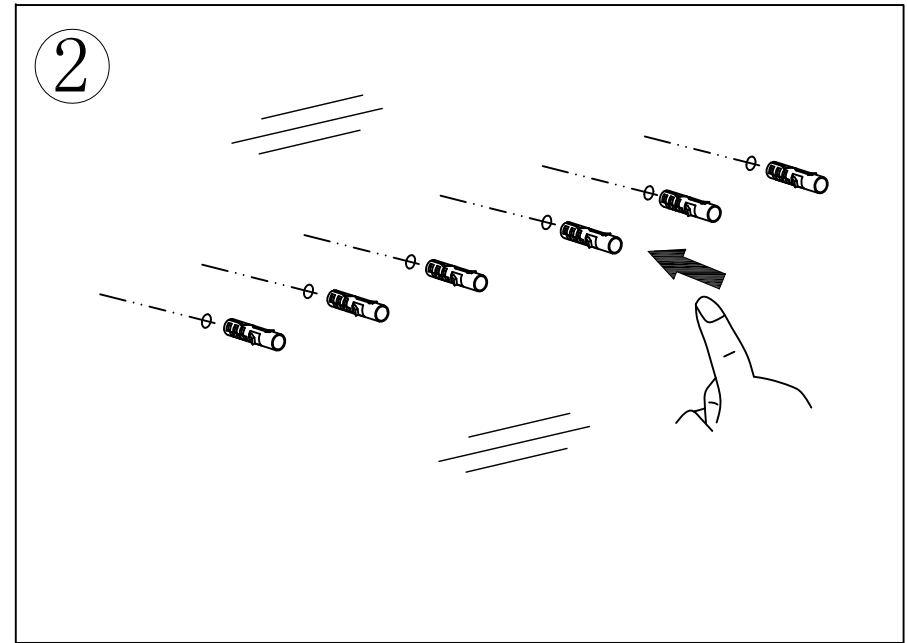
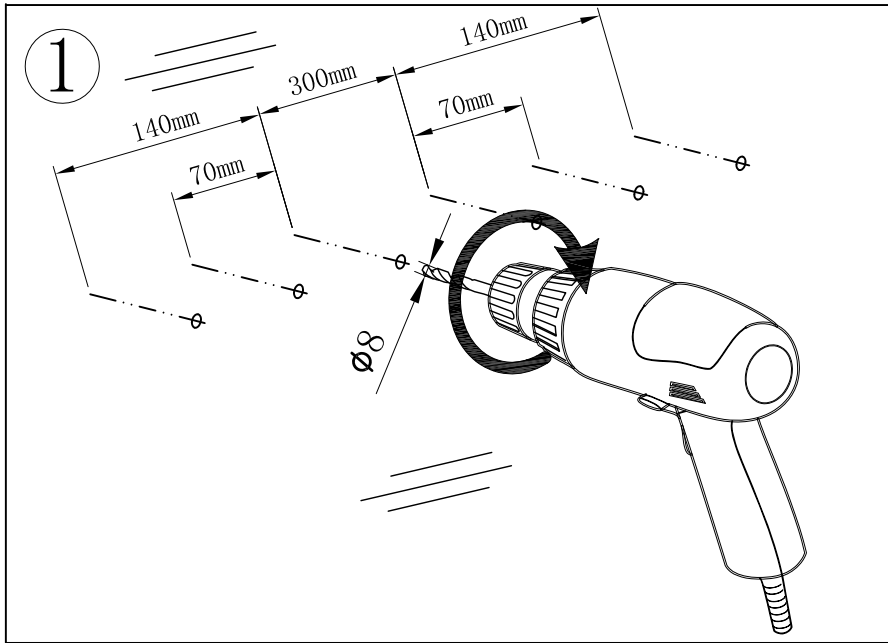
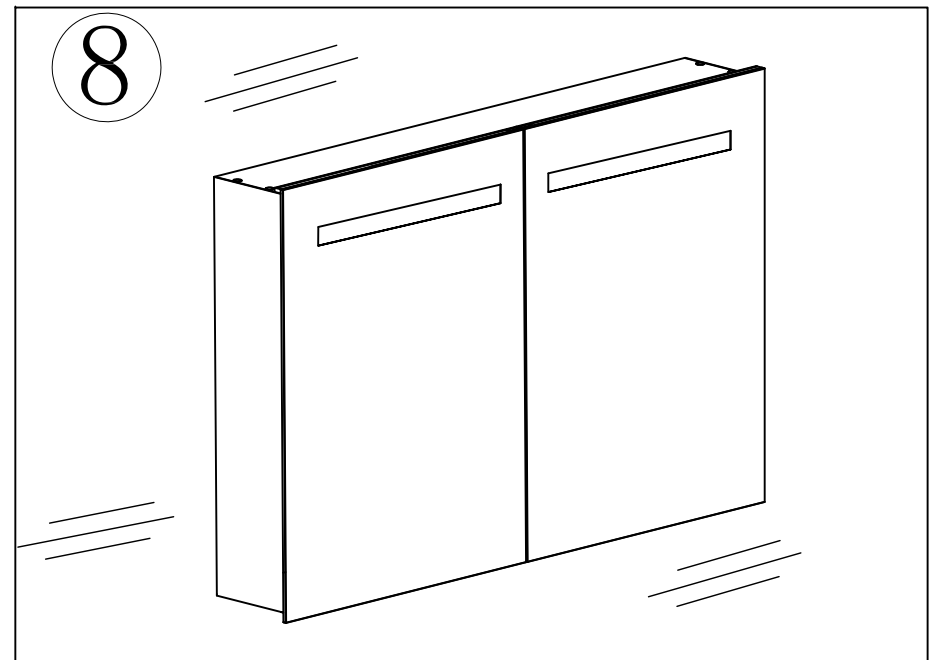
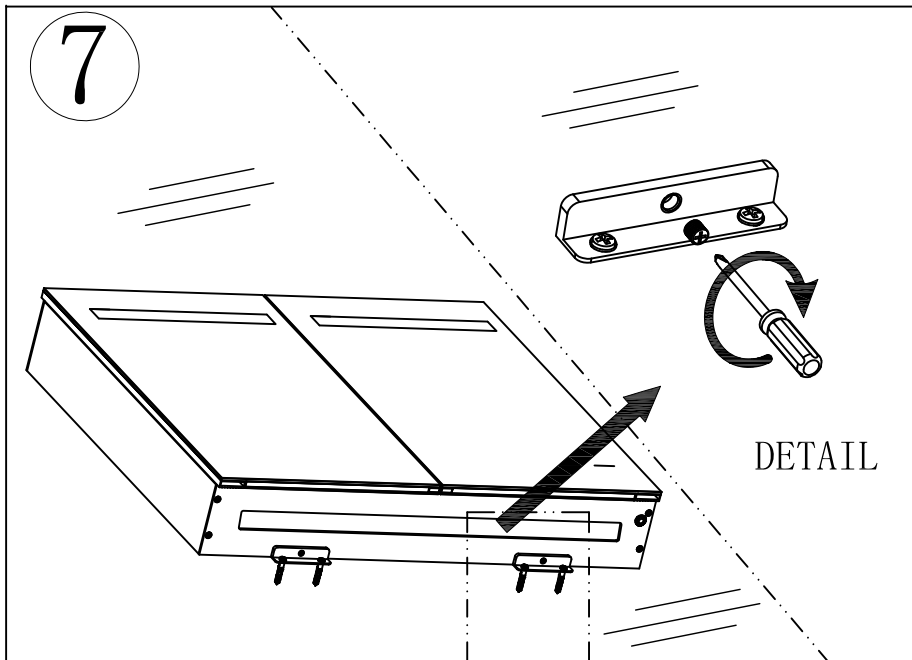
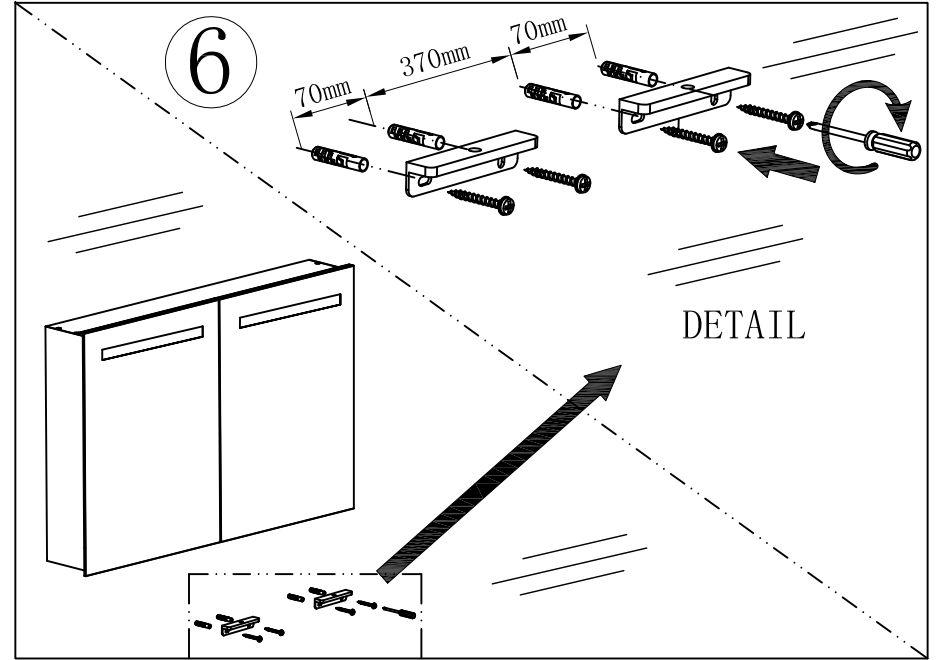
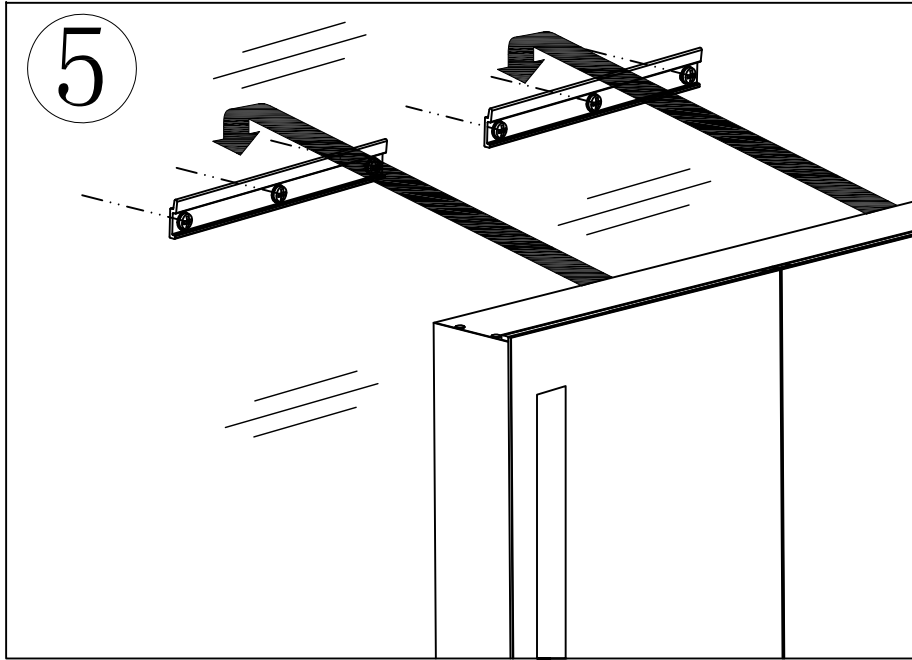

FIXING INSTRUCTIONS FOR THE ADJUSTABLE GLASS SHELVES

